

BAH Electric Heater Packing List

Heaters & Accessories

Effective 09-01-16
mm-dd-yy

All orders are subject to acceptance by Brant Radiant Heaters Limited, Paris, Ontario at prices in effect at date of shipment. All prices are F.O.B. Paris, Ontario. All Provinces, Federal, or Municipal taxes in effect at the time of shipment or imposed at any future time on our products shall be the responsibility of the customer. We reserve the right to change specifications on our products without prior notice to the customer.

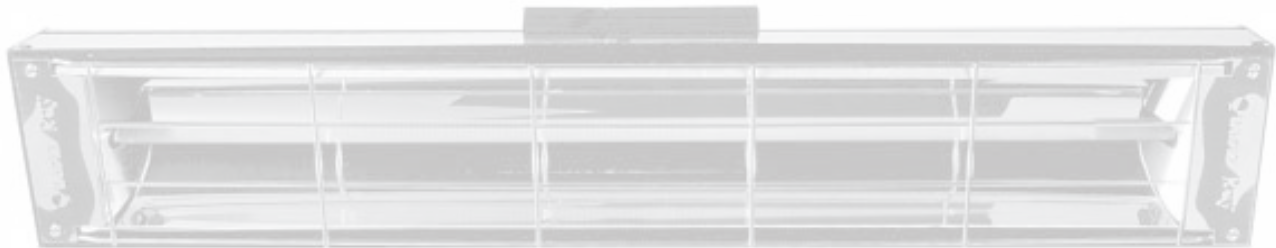

Medium Wave, Electric, Infrared Heaters

15% restocking charge on returned items, within 30 days from day of sale.

34 Scott Ave., Paris, Ontario N3L 3R1

Phone: 519-442-7823 • Fax: 519-442-7321

www.brantradiant.com • sales@brantradiant.com

The following key symbols (found within) designate the following:

SYMBOL	DESCRIPTION
<u>Underlined Item</u>	New item or price, from prior accessory guide, or heater price sheet.
Part No. in BOLD	An item that has further technical information available, ex.: spec sheet, instructions, etc.

Replacement parts information is available online at www.reverberray.com/parts and in the product manual.

5 ft. Heaters and Elements when shipped on a truck line service need to be placed on a 5 ft. skid. A 5 ft skid charge is \$10.00 flat rate. Please specify Wide (40 x 64) or Narrow (20 x 64)

BAH SERIES ELECTRIC INFRA-RED HEATERS

Available Models	Volts	kW	Watts	Amp	Phase	Equivalent		Overall			
						BTU/H	Length	Width	Height	Weight	Cert.
BAH-18-A-05	120	0.5	500	4.2	Single	1,700	18"	6.75"	6.4"	8 lbs.	CSA
BAH-25-A-10	120	1.0	1,000	8.3	Single	3,400	25"	6.75"	6.4"	10 lbs.	CSA
BAH-25-B-10	208	1.0	1,000	4.8	Single	3,400	25"	6.75"	6.4"	10 lbs.	CSA
BAH-25-C-10	240	1.0	1,000	4.2	Single	3,400	25"	6.75"	6.4"	10 lbs.	CSA
BAH-35-A-17	120	1.7	1,750	14.0	Single	5,900	35"	6.75"	6.4"	13 lbs.	CSA
BAH-35-B-17	208	1.7	1,750	8.3	Single	5,900	35"	6.75"	6.4"	13 lbs.	CSA
BAH-35-C-17	240	1.7	1,750	7.0	Single	5,900	35"	6.75"	6.4"	13 lbs.	CSA
BAH-35-G-17	480	1.7	1,750	3.6	Single	5,900	35"	6.75"	6.4"	13 lbs.	CSA
BAH-45-B-25	208	2.5	2,500	12.0	Single	8,500	45"	6.75"	6.4"	16 lbs.	CSA
BAH-45-C-25	240	2.5	2,500	10.0	Single	8,500	45"	6.75"	6.4"	16 lbs.	CSA
BAH-45-G-25	480	2.5	2,500	5.2	Single	8,500	45"	6.75"	6.4"	16 lbs.	CSA
BAH-60-B-30	208	3.0	3,000	14.0	Single	10,200	60"	6.75"	6.4"	20 lbs.	CSA
BAH-60-C-30	240	3.0	3,000	12.0	Single	10,200	60"	6.75"	6.4"	20 lbs.	CSA
BAH-60-G-30	480	3.0	3,000	6.2	Single	10,200	60"	6.75"	6.4"	20 lbs.	CSA
BAH-60-C-40	240	4.0	4,000	16.5	Single	13,500	60"	6.75"	6.4"	20 lbs.	CSA
BAH-60-G-40	480	4.0	4,000	8.3	Single	13,500	60"	6.75"	6.4"	20 lbs.	CSA
BAH-60-D-40	575	4.0	4,000	7.0	Single	13,500	60"	6.75"	6.4"	20 lbs.	CSA

AVAILABLE BAH SERIES MODELS

Qty.	Models	Brooder	Quantity
	BAH-18-A-05	Yes	
	BAH-25-A-10	Yes	
	BAH-25-B-10	Yes	
	BAH-25-C-10	Yes	
	BAH-35-A-17	Yes	
	BAH-35-B-17	Yes	
	BAH-35-C-17	Yes	
	BAH-35-G-17	Yes	
	BAH-45-B-25 *	No	
	BAH-45-C-25 *	No	
	BAH-45-G-25 *	No	
	BAH-60-B-30 *	No	
	BAH-60-C-30 *	No	
	BAH-60-G-30 *	No	
	BAH-60-C-40 *	No	
	BAH-60-G-40 *	No	
	BAH-60-D-40 *	No	

QUARTZ REPLACEMENT ELEMENTS

Qty.	Models	Voltage	Watts	Quantity
	QT-18-A-05	120V	500	
	QT-25-A-10	120V	1,000	
	QT-25-B-10	208V	1,000	
	QT-25-C-10	240V	1,000	
	QT-35-A-17	120V	1,750	
	QT-35-B-17	208V	1,750	
	QT-35-C-17	240V	1,750	
	QT-35-G-17	480V	1,750	
	QT-45-B-25	208V	2,500	
	QT-45-C-25	240V	2,500	
	QT-45-G-25	480V	2,500	
	QT-60-B-30	208V	3,000	
	QT-60-C-30	240V	3,000	
	QT-60-G-30	480V	3,000	
	QT-60-C-40	240V	4,000	
	QT-60-G-40	480V	4,000	
	QT-60-D-40	575V	4,000	



-All heaters are stock items, please specify for Brooder use.



-Approximate surface temperature of 540°C

* Refer to factory for method of shipping, Skid charge may be applicable.

Limited Warranty: 1-Year on BAH Series heaters. 90-Days on Quartz replacement elements.

ELECTRIC ACCESSORIES

PART NO.	DESCRIPTION	Quantity
 MB-1	Mounting Bracket. Used for wall and ceiling mounting. Total range of adjustment is 180°. Sold in pairs. NOTE: Clearance to combustibles must be maintained.	
 QR-EC	Element Clip. Screws into the body of the heater to hold the element in place. Sold as one piece.	
 IRH-50	Brooder legs to be added to stock heater for brooder use, comes with appropriate hardware.	

PART NO.	DESCRIPTION	Quantity
 [WR-S] QR-115A	1G65-633 Electric heater thermostat with 4.4°C - 26.6°C range. Double line break when positive off. For use on BAH Series 120V heaters. 22 amps at 120 VAC non-inductive. Common thermostat when amperage permits.	
 [1G66-633] QR-115B	1G66-633 Electric heater thermostat with 4.4°C - 26.6°C range. Double line break when positive off. For use on BAH Series heaters 208V and 240V. 22 amps at 240 VAC non-inductive. Common thermostat when amperage permits.	

BAH DUAL FRAME ASSEMBLIES		
PART NO.	DESCRIPTION	Quantity
<u>EL-551</u>	BAH-18 Dual Frame	
<u>EL-553</u>	BAH-25 Dual Frame	
<u>EL-555</u>	BAH-35 Dual Frame	
<u>EL-557</u>	BAH-45 Dual Frame	
<u>EL-559</u>	BAH-60 Dual Frame	

* All Dual Frames are 17" wide, length corresponds to model number.

BAH TRI FRAME ASSEMBLIES		
PART NO.	DESCRIPTION	Quantity
<u>EL-550</u>	BAH-18 Tri Frame	
<u>EL-552</u>	BAH-25 Tri Frame	
<u>EL-554</u>	BAH-35 Tri Frame	
<u>EL-556</u>	BAH-45 Tri Frame	
<u>EL-558</u>	BAH-60 Tri Frame	

* All Tri Frames are 24" wide, length corresponds to model number.

BAH DUAL FRAME ASSEMBLIES PARTS		
NO.	DESCRIPTION	Qty.
1	MB-1 Mounting Brackets (sold separately)	4
2	#10-24-1½ Machine Screw	8
3	#10-24 Hex Nut	8
4	¼-20 Hex Nut	4
5	¼-20 UNC-0.75 Hex Bolt-UNC	4
6	¼ Lock Washers	4
7	#10 Lock Washer	8
8	5/16-18 Hex Nut	8
9	5/16-3.0 Eyebolt	4
10	5/16 Lock Washer	4

BAH TRI FRAME ASSEMBLIES PARTS		
NO.	DESCRIPTION	Qty.
1	MB-1 Mounting Brackets (sold separately)	6
2	#10-24-1½ Machine Screw	12
3	#10-24 Hex Nut	12
4	¼-20 Hex Nut	6
5	¼-20 UNC-0.75 Hex Bolt-UNC	6
6	¼ Lock Washers	6
7	#10 Lock Washer	12
8	5/16-18 Hex Nut	8
9	5/16-3.0 Eyebolt	4
10	5/16 Lock Washer	4

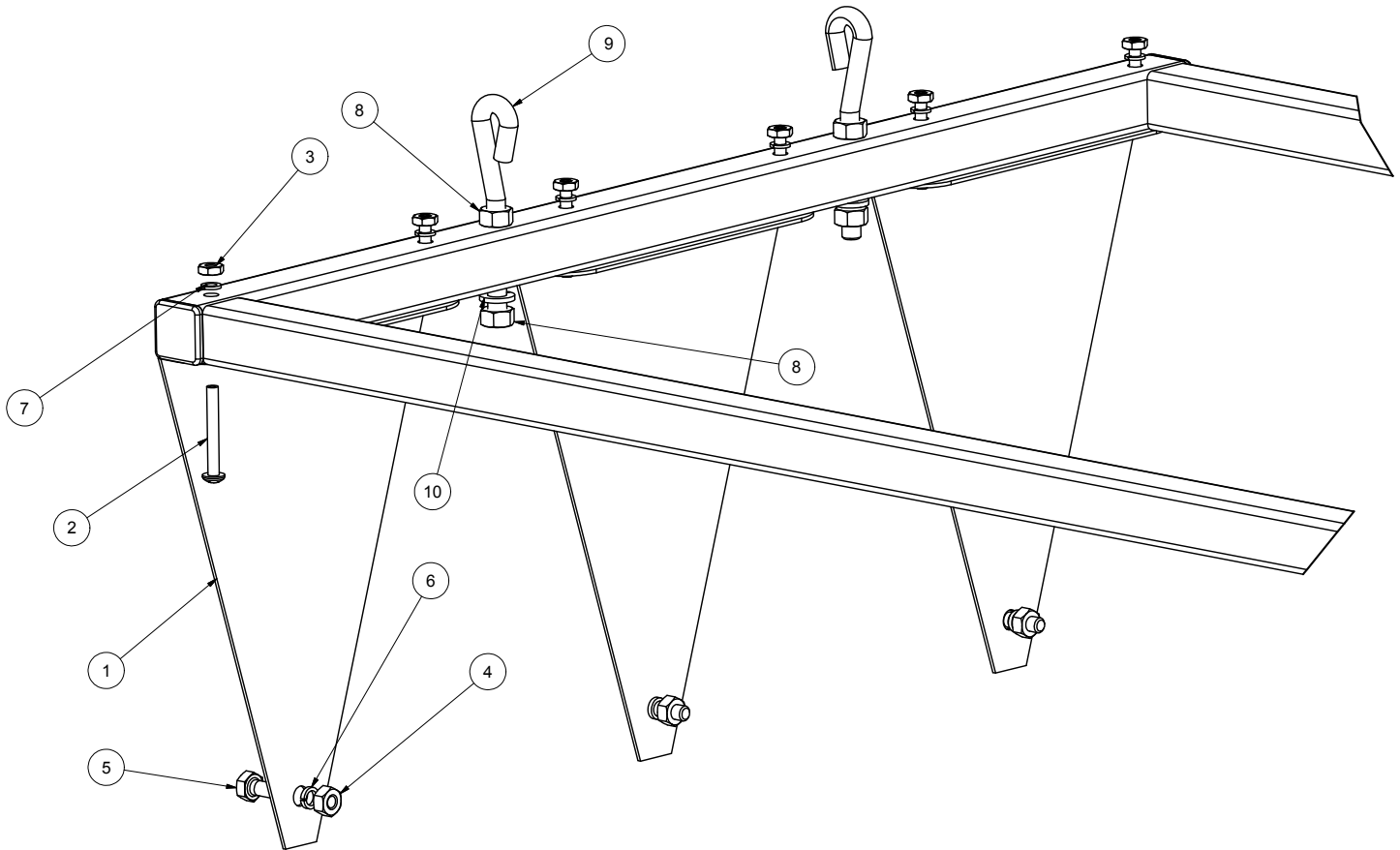

ENGINEERING SPECIFICATIONS

HEAT PATTERN

Mounting Height	Areas Heated in feet.			
	1 kW	1.75 kW	2.5 kW	3 & 4 kW
7 feet	8 x 10	8 x 11	8 x 12	8 x 13
8 feet	9½ x 11½	9½ x 12	9½ x 13	9½ x 14½
9 feet	10½ x 12½	10½ x 13	10½ x 14	10½ x 15½
10 feet	-	11½ x 14½	11½ x 15½	11½ x 16½
11 feet	-	12½ x 15	12½ x 16	12½ x 17½
12 feet	-	-	14 x 18	14 x 19
13 feet	-	-	15 x 18.9	15 x 20
14 feet	-	-	-	16 x 21
15 feet	-	-	-	17½ x 22½

WATTS DENSITY AT FLOOR LEVEL

Mounting Height	Density in Watts				
	1 kW	1.75 kW	2.5 kW	3 kW	4 kW
7 feet	12.4	20.0	26.5	28.8	38.4
8 feet	9.2	16.1	20.1	22.0	29.4
9 feet	7.6	13.4	16.8	18.6	24.9
10 feet	-	11.1	14.5	16.0	21.6
11 feet	-	9.3	12.5	14.0	18.7
12 feet	-	-	10.0	11.2	15.0
13 feet	-	-	8.8	10.0	13.3
14 feet	-	-	-	8.9	11.9
15 feet	-	-	-	-	10.9

ESTIMATING REQUIRED LOADING

Type of Building	Watts Required Per Square Foot At Floor Level
Insulated building	10
Uninsulated	16
Outdoor Sheltered	25-30
Outdoor Unsheltered	30-45

CLEARANCE TO COMBUSTIBLES

TOP - 12 Inches (30 cm)

SIDES - 18 Inches (46 cm)

BOTTOM - 24 Inches (61 cm)

