

Designer Series Patio Heater Packing List

Heaters & Accessories

Effective 09-01-16

mm-dd-yy

All orders are subject to acceptance by Brant Radiant Heaters Limited, Paris, Ontario at prices in effect at date of shipment. All prices are F.O.B. Paris, Ontario. All Province, Federal, or Municipal taxes in effect at the time of shipment or imposed at any future time on our products shall be the responsibility of the customer. We reserve the right to change specifications on our products without prior notice to the customer.



Gas-Fired, High Intensity, Designer Series Patio Heaters

15% restocking charge on returned items, within 30 days from day of sale.

34 Scott Ave., Paris, Ontario N3L 3R1
Phone: 519-442-7823 • Fax: 519-442-7321
www.brantradiant.com • sales@brantradiant.com

TABLE OF CONTENTS

DSCS Series Heaters and Accessories PricingPage 2	DSCS Series Replacement Parts.....Page 4
DSCS Series Parts BreakdownPage 3	Discontinued PH Series Replacement PartsPage 4

The following key symbols (found within) designate the following:

SYMBOL	DESCRIPTION
<u>Underlined Item</u>	New item or price, from prior accessory guide, or heater price sheet.
Part No. in BOLD	An item that has further technical information available, ex.: spec sheet, instructions, etc.

DSC DESIGNER SERIES INFRARED PATIO HEATER STANDARD FEATURES

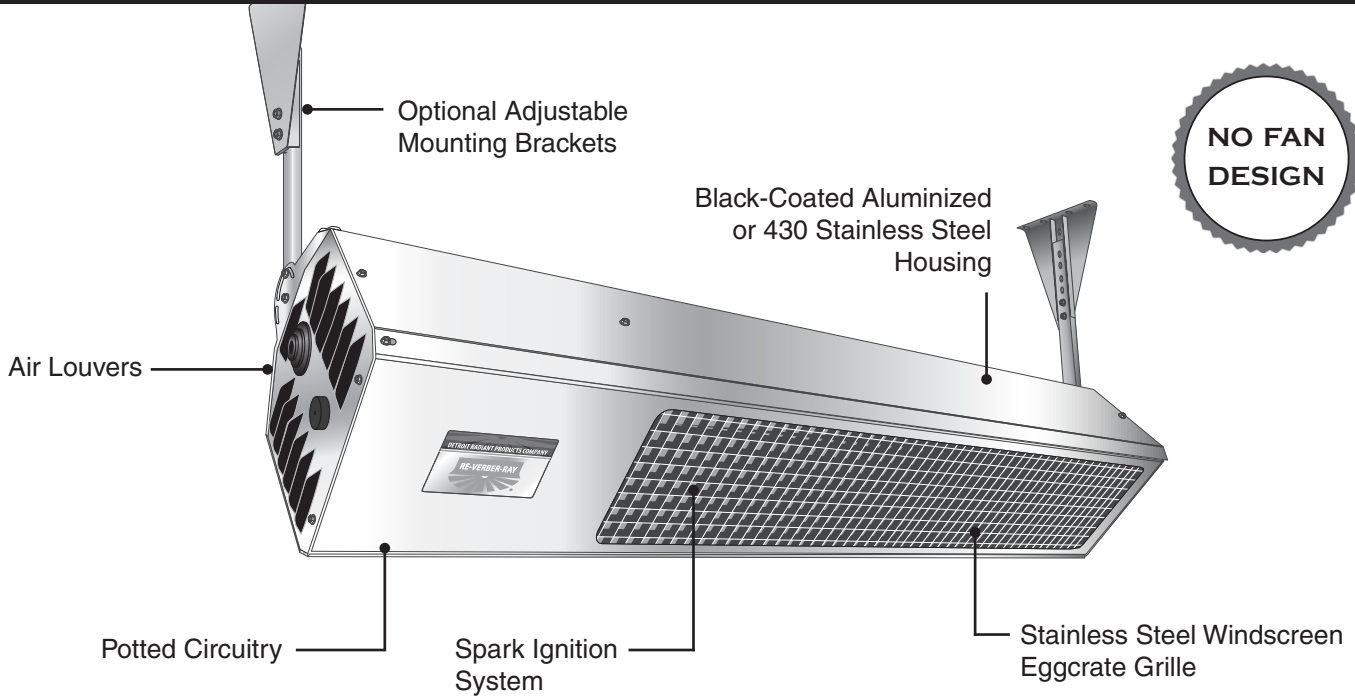

DSCS SERIES PRICES





QTY.	MODEL	GAS TYPE	BTU/H	DIMENSIONS			TYP. OR RCMD. MOUNTING HEIGHTS ¹	NET SHIP WEIGHT ²	QUANTITY
				HEIGHT	LENGTH	DEPTH			
	DSCS-31N	Natural	31,000	10.9" (to top of bracket)	48.4"	9.0"	8.0 ft. to 12 ft.	59 lbs.	
	DSCS-31P	Propane	31,000				8.0 ft. to 12ft.		
	DSCS-34N	Natural	34,000				8.5 ft. to 13.0 ft.		
	DSCS-31N-SS	Natural	31,000	10.9" (to top of bracket)	48.4"	9.0"	8.0 ft. to 12 ft.	59 lbs.	
	DSCS-31P-SS	Propane	31,000				8.0 ft. to 12ft.		
	DSCS-34N-SS	Natural	34,000				8.5 ft. to 13.0 ft.		

¹ Typical or recommended mounting heights are provided as a guideline. Actual conditions may dictate variances from the above data.

² Shipping weight is 65 lbs. with optional mounting bracket (PH-BKT). Box dimensions 54"x17"x15". Truckline transportation for orders containing three or more units is recommended.

NOTE: Gas connection requires a 1/2" NPT adapter fitting.

DSC SERIES ACCESSORIES

PART NO.	DESCRIPTION	Quantity	PART NO.	DESCRIPTION	Quantity
 PH-BKT	Adjustable Mounting Bracket. Preset hardware allows the PH Series heater to be installed at an angle between 0°-30° from horizontal. Includes black wall brackets, black connecting arms, zinc-coated nuts, bolts & washers. One set per heater. NOTE: Clearance to combustibles must be maintained at all times.		 WEP-TS	Weatherproof enclosure package with 4-hour timer and on-off control. Ideal for use in outdoor heating applications where timer control is desired. Package for two-stage scenarios. Can operate up to 120V-20 amp. Can also be used for 24V switching. Field assembly and wiring required.	
PH-BKT-SS	304 Series stainless steel PH-BKT. Includes stainless steel wall brackets, stainless steel connecting arms, and stainless steel nuts, bolts & washers. One set per heater. NOTE: Clearance to combustibles must be maintained at all times. For use with PH-SS Series.		 FC-24PVC	Twenty-four inch stainless steel flexible gas (1/2" I.D.) connector, coated. Not for use with gas pressures in excess of 1/2 PSI. Consult local codes for compliance.	
 THCS	5' chain set with 2 'S'-hooks. Used for hanging heater. Two needed per heater.		 PLQ	Clearance Safety Limit Sign. 24 ga. aluminum 10" x 7". Sign is designed to be hung or adhered at clearance to combustible limit. Repeats clearance warnings.	

Heater Components

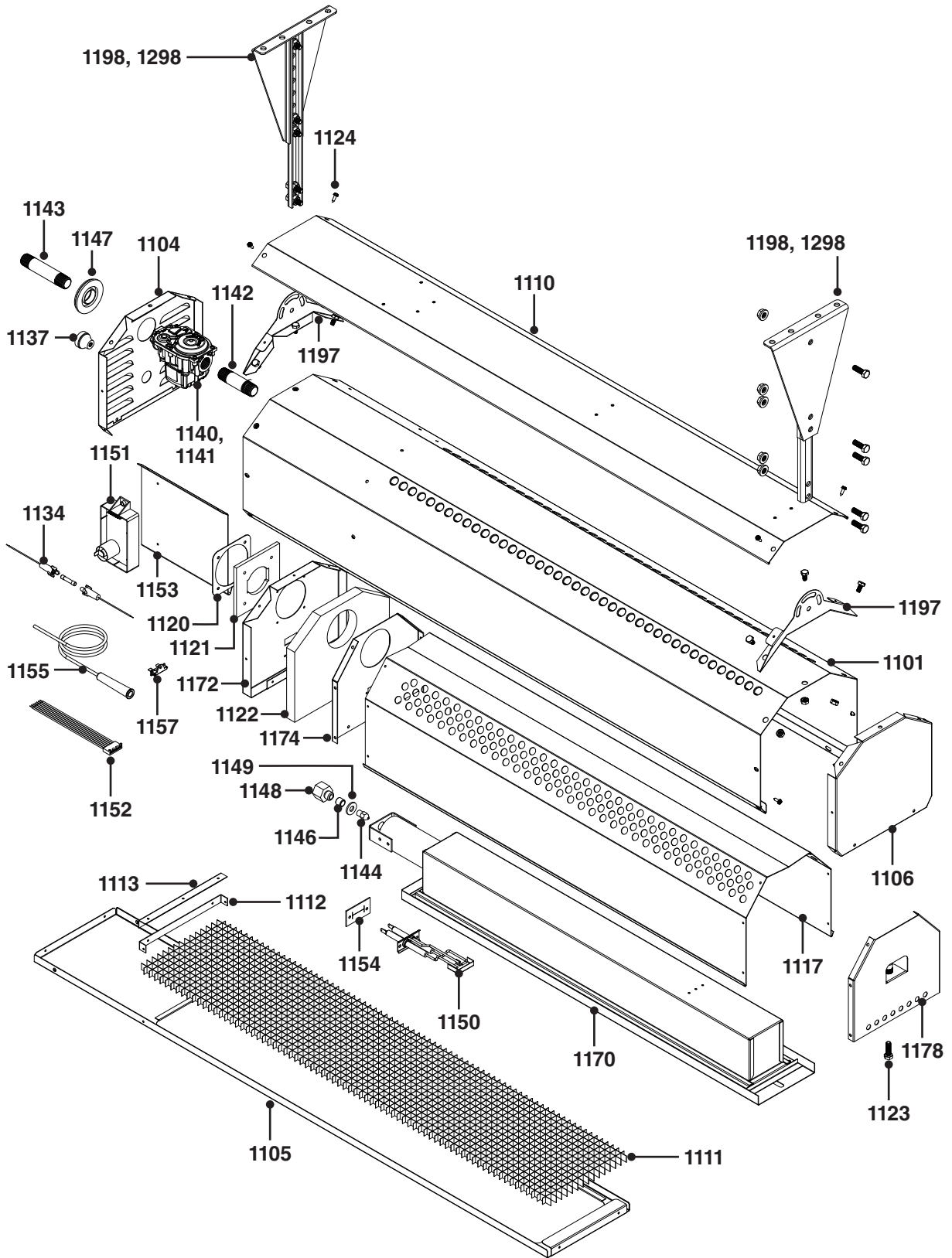

DSCS SERIES REPLACEMENT PARTS

Part No.	Description	Quantity
PH-1105	Service Access Panel	
PH-1111	Egg Crate	
PH-1120	Venturi Gasket Holder	
PH-1121	Venturi Gasket	
PH-1134	In-Line Fuse	
PH-1137	Thermostat Wire Grommet	
PH-1140	Gas Valve (Natural Gas)	
PH-1141	Gas Valve (Propane)	
PH-1144	Gas Orifice (Specify Model)	
PH-1150	Electrode	
PH-1151	Circuit Board	
PH-1152	Circuit Board Wiring Harness	
PH-1154	Electrode Gasket	
PH-1155	High Voltage Wire w/ Boot	
PH-1157	Thermal Fuse	
PH-1170	Burner Assembly	
PH-1174	Reflector End - Ignition Side	
PH-1178	Reflector End - Burner Support w/ Nutsert	