

QT Series Packing List

Heaters & Accessories

Effective 09-01-15
mm-dd-yy

All orders are subject to acceptance by Brant Radiant Heaters, Paris, Ontario at prices in effect at date of shipment. All prices are F.O.B. Paris, Ontario. All Province, Federal, or Municipal taxes in effect at the time of shipment or imposed at any future time on our products shall be the responsibility of the customer. We reserve the right to change specifications on our products without prior notice to the customer.



Gas-Fired, Quad Tube Design, Low Intensity Infrared Heaters

34 Scott Ave., Paris, Ontario N3L 3R1
Phone: 519-442-7823 • Fax: 519-442-7321
www.brantradiant.com • sales@brantradiant.com

15% restocking charge on any returned items.

TABLE OF CONTENTS

QT Series Heater Prices	2	Accessories & Upgrade Items	3
Available Models & Options	2	Design Considerations	4

The following key symbols (found within) designate the following:

SYMBOL	DESCRIPTION
<u>Underlined Item</u>	New item or price, from prior accessory guide, or heater price sheet.
Part No. in BOLD	An item that has further technical information available, ex.: spec sheet, instructions, etc.

NOTE: Add-ons must be ordered as a separate line item and tagged to the appropriate heater.

QT SERIES BURNER PACKAGES				
Model No.	Description	Gas Type	Input BTU/h High Fire	List Price
BRN QTD-60N	QT - Tube Burner - Dual Stage	Natural	60,000	
BRN QTD-80N	QT - Tube Burner - Dual Stage	Natural	80,000	
BRN QTD-60P	QT - Tube Burner - Dual Stage	Propane	60,000	
BRN QTD-80P	QT - Tube Burner - Dual Stage	Propane	80,000	
BRN QTS-40N	QT - Tube Burner - Single Stage	Natural	40,000	
BRN QTS-60N	QT - Tube Burner - Single Stage	Natural	60,000	
BRN QTS-80N	QT - Tube Burner - Single Stage	Natural	80,000	
BRN QTS-40P	QT - Tube Burner - Single Stage	Propane	40,000	
BRN QTS-60P	QT - Tube Burner - Single Stage	Propane	60,000	
BRN QTS-80P	QT - Tube Burner - Single Stage	Propane	80,000	

NOTE: Outdoor Approval Kit (P/N: OD-KIT) **MUST** be added to the heater when applying heaters outdoors.

QT SERIES TUBE AND REFLECTOR PACKAGES		
Model No.	Description	List Price
TPK-QT	QT - U Tube Reflector and AK Kit	

Shipping/Boxing:

B = Burner Box (45#) & (31.5"L x 17.5"W x 15.5"H)
T = Large Tube Box (88#) & (91"L x 31"W x 14"H).



IMPORTANT: Burner and tube components are sold separately - complete assemblies require both BRN burner **and** TPK-QT tube packages.

KIT CONTENTS			
Box	Part No.	Description	Quantity
B	TP-33B	1/2" Shut-Off Valve (Ball Valve & Inlet Tap)	1
B	QT Manual	Series Manual	1
T	TP-13	Self Drilling Screws for Vent Pipe	9
B	RH-1	1/2" Type 1 Rubber Hose	1
B	TP-6021B	Fiberfrax Tube Flange Gasket	2
T	TP-6022	5/16" - 18 Keps Nut	13
T	TP-6075	81" x 4" Spiral Vent Pipe	1
T	TP-6078	2.25" Reflector Support	8
T	TP-6080	4" Vent Adapter Fitting	1
T	TP-6085	Reflector Angle Limitation Bracket	2

B [Packed with burner]

T [Packed with tube & reflector assembly]

LIMITED WARRANTY INFORMATION			
STANDARD WARRANTY	BURNER BOX COMPONENTS	TUBES/ EXCHANGERS	BURNER
QTD, QTS	1 Year	3 Years	5 Years



All limited warranties, are defined in the Series Manual for the particular Series of heaters. Please contact the factory for further information on the terms and conditions.



RECOMMENDED MOUNTING HEIGHTS [†]		
BTU Range	Typical Use	
	Single Stage	Dual Stage
40,000	8 ft. to 12 ft.	N/A
60,000	9 ft. to 13 ft.	8 ft. to 13 ft.
80,000	10 ft. to 14 ft.	9 ft. to 14 ft.



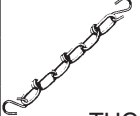

[†] Recommended mounting heights are listed as a guideline. If infrared heaters are mounted too low or too high, they may produce adverse results.







ADD-ON / UPGRADE ITEMS		
PART NO.	DESCRIPTION	LIST \$
OD-KIT	Outdoor approval kit for QTD and QTS Series. Option MUST be added to the heater when applying heaters outdoors. Includes: PC-36, 24V control cord (when applicable), SILSEAL, 90° air inlet collar and certificate.	

OTHER ACCESSORIES		
PART NO.	DESCRIPTION	LIST \$
 RH-1	30 in. (1/2" I.D.) rubber hose connector for low intensity heaters applied in Canada (25 - 125 MBH).	

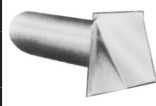
HARDWARE ACCESSORIES		
PART NO.	DESCRIPTION	LIST \$
 THCS	Five foot chain set with 2) S-hooks used for hanging heater. Bulldog coil chain, trade size #1, wire gauge 12, and a working load limit of 155 lbs. each. Chain length is 5 ft. NOTE: QT Series has 3 hanging points.	
 S-HOOK	Chain set "S" hook	

AIR COMPONENTS		
PART NO.	DESCRIPTION	LIST \$
 AIRH	4" flexible air inlet rubber hose with DWV adapter affixed. Mates to 4" DWV pipe. Clear color for visibility. Includes 4" DWV adapter and worm clamp. 18" in length.	
 WIV-4	Wall inlet cap, 4" O.D. with bird screen. For use with outside air option. Bird screen insures open air flow to unit. Used for 0-20' of 4" intake.	

CONTROL OPTIONS		
PART NO.	DESCRIPTION	LIST \$
 WR-S	White Rogers thermostat. 4,4° to 26,6°C range. White plastic cover, 120-277 VAC, 22.0 amps. May be used to switch either 120V, 240V, or 277V. Consult amp rating unit for proper sizing.	
 ETD-5M	Columbus Electric two-stage , double throw, low or line voltage thermostat. 35°F to 75°F range (24, 120 or 220V). Non-adjustable, preset 2° high/low fire differential. UL Listed and CSA Certified.	
 TH-BRTS	Braeburn two-stage , non-programmable thermostat. 45°-90°F range with preset 2°F high-low differential. 3 Amp @ 24VAC or battery powered. Features include °C/°F display and adjustable temperature differential.	
 TF-115	Thermostat with rain tight enclosure and 40° to 100°F range. Rugged weatherproof control for use in agricultural, industrial and commercial environments with heavy moisture atmospheres. 16.0 FLA, 25.0 amps resistive at 120V. Watertight NEMA 4X when used with watertight connections (24, 120 or 220V). Consult amp rating of unit for proper sizing.	
 TH-109	Two-stage t-stat with rain tight enclosure. 40° to 100°F range. Rugged weatherproof control for use in agricultural, industrial, and commercial environments with heavy moisture atmospheres. Consult amp rating of unit for proper sizing. 24, 120, 208, 240 and 277 VAC.	

4" VENT MATERIALS		
PART NO.	DESCRIPTION	LIST \$
 WVE-GALV	Galvanized steel vent outlet cap 4 in. O.D. with flapper. Flapper insures proper static pressure for proper unit operation. Must be used with unvented units. Known as WVE-4.	
 SWD-4	Duravent sidewall vent cap. All aluminum construction. Diameter is 8-3/4 in.	
 4-DSK	4 in. Duravent sidewall vent kit with all items for sidewall venting. Includes: SWD-4, WT-4, 18BV-4, DHC-4. No vent pipe material is included. 29 in. long when fully assembled.	
 WT-4	4 in. wall thimble. Protection for venting through a sidewall application. Measures 8.5 in. outer diameter, 6.5 in. inner diameter. Adjustable 4 in. to 6 in. depth.	
 DHC-4	4 in. draft hood connector. B-C adapter for connecting vent pieces.	
 SC-4	4 in. storm collar. For use with 4 in. venting through the roof. Galvanized steel. Prevents rain from entering flashing.	

NOTE: All heaters come standard requiring an external 24V supply for control voltage. An alternate operation is available and is field selectable to allow unit to supply 24V power for the thermostatic connections. See applicable series manual for additional details. For additional thermostats, refer to the Tube Heater and Accessories Price Book.

To ensure a properly designed heating system, a layout should be developed for the correct placement of the heating appliance, vents and combustion air intake ducts. Inspect and evaluate the mounting conditions, vent locations, clearance to combustibles, gas supply and wiring.

⚠ CAUTION

Sprinkler systems containing propylene glycol or other flammable substances are not to be used in conjunction with this heater without careful consideration for and avoidance of potential fire or explosion hazards. For further information consult NFPA 13.

IMPORTANT: Fire sprinkler heads must be located at an appropriate distance from the heater. This distance may exceed the published clearance to combustibles as posted on the heater. Certain applications may require the use of high temperature sprinkler heads or relocation of the heaters.



NOTE: The effective infrared surface temperature of a person or object may be diminished with wind above 5 mph. The use of adequate wind barrier(s) may be required.

QTD Series Clearance to Combustibles, Mounting Heights and Coverages

Model No.	Input BTU/h	Clearance to Combustibles Data					Recommended Mounting Height (ft.)	Approximate Coverage Area (L x W)
		Top	Sides	Below	Back	End		
QTD-60 [N,P]	60,000	10	36	40	6	12	8 to 13	30 x 45
QTD-80 [N,P]	80,000	10	36	40	6	12	9 to 14	40 x 60

NOTE: Factory recommended mounting heights and coverages are listed as a guideline. If infrared heaters are mounted too low or too high, they may result in discomfort or lack of heat.

SIDE VIEW

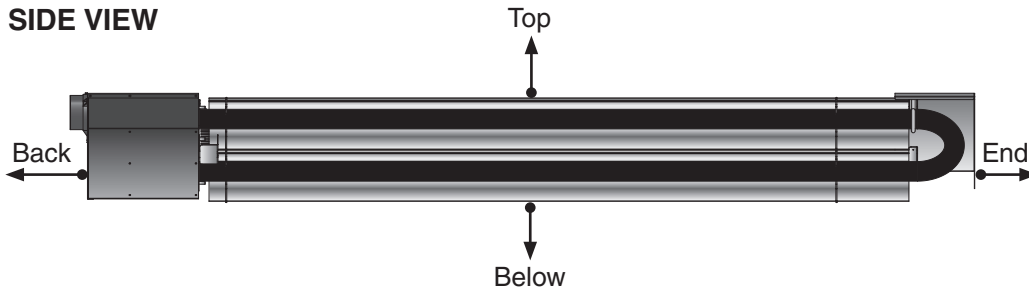

END VIEW

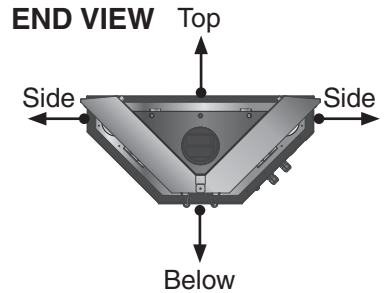

Application Guidelines

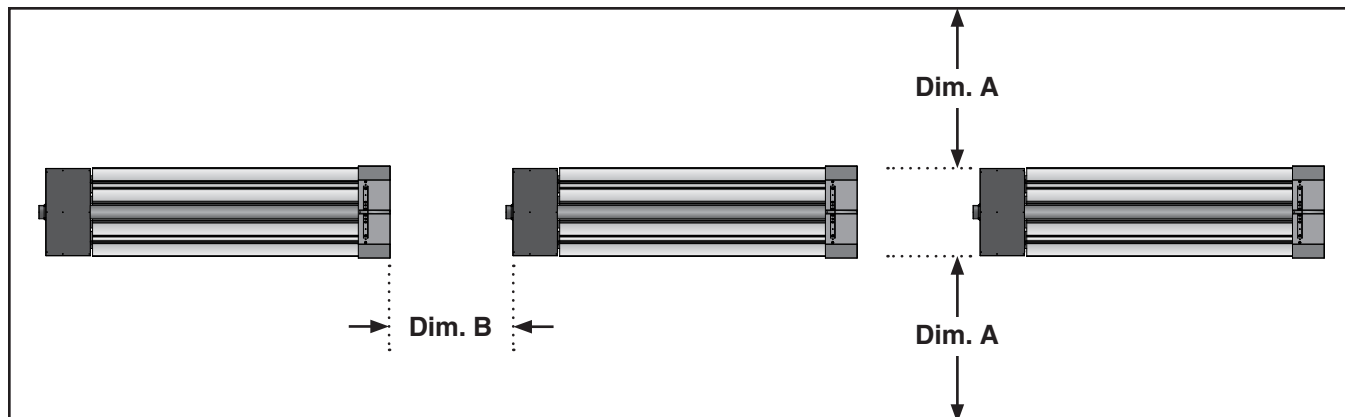

DIM A - Distance from heater to wall = 8 ft. to 20 ft. **DIM B** - Distance between heaters = 12 ft. to 28 ft.

NOTE: Dimensions A & B are based upon heaters hung at the factory recommended mounting height.