

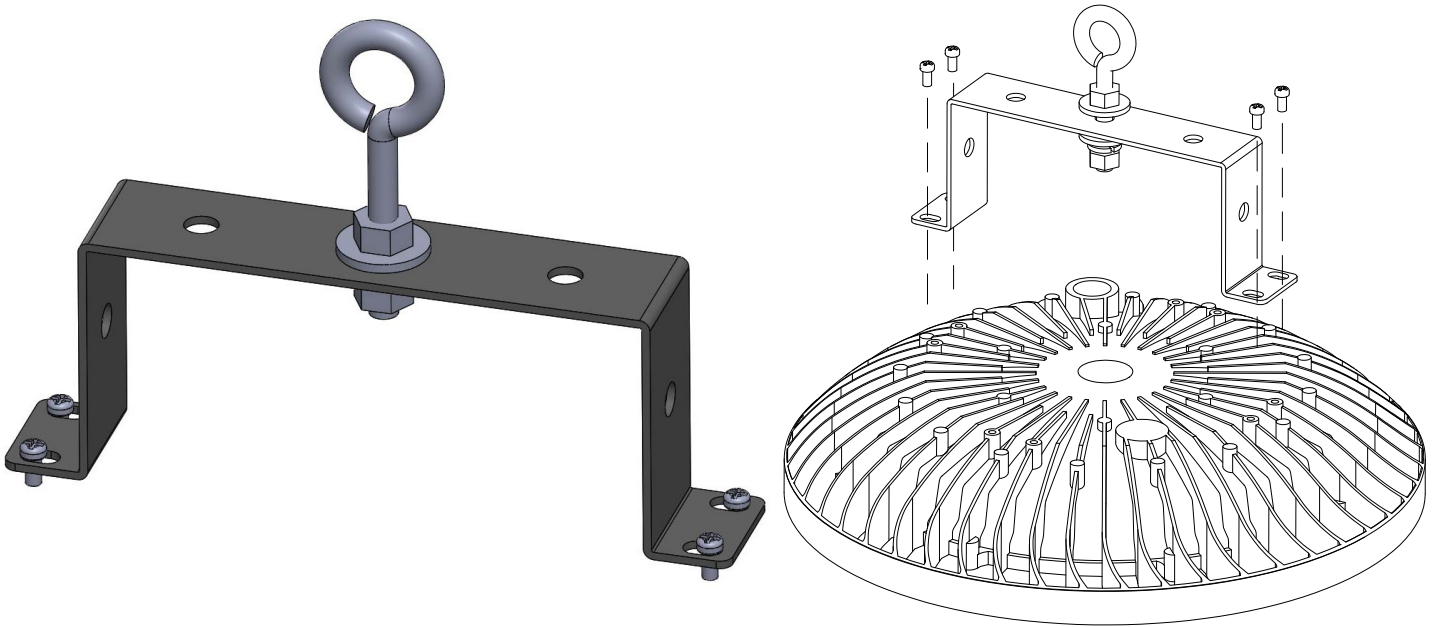

# LRA-HSB Bracket Kit

## LED Horse Shoe Bracket

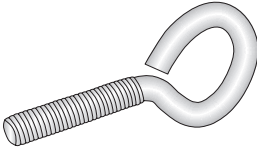
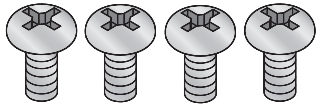
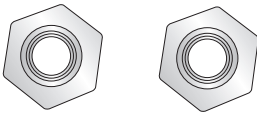
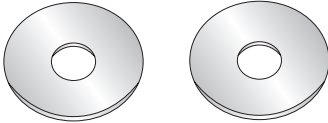
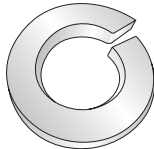

### LRA-HSA Kit Contents

<p>Horseshoe Bracket Qty. 1</p> 	<p>Eye Bolt Qty. 1</p> 	<p>Screws Qty. 4</p> 
<p>Nuts Qty. 2</p> 	<p>Flat Washer Qty. 2</p> 	<p>Spring Washer Qty. 1</p> 



BRANT RADIANT HEATERS LTD

34 Scott Ave., Paris, Ontario, Canada N3L 3R1

tel 519.442.7823 or 800.387.4778 fax 519.442.7321

e-mail sales@brantradiant.com web www.brantradiant.com